

Nextech Eurocraft™ Trading Desks Specification Guide

Step 1

Specify Size Of Trading Desk

Trading Desks are available in 3" increment widths (starting from 36") and 72", 64", & 60" depths.

All desk worktops are 29 1/2" A.F.F. (Above Finished Floor)

All sizes are customizable, from width to depth and even height.

Common desk sizes are as follows (Width x Depth) –

36" x 72"	36" x 64"	36" x 60"
42" x 72"	42" x 64"	42" x 60"
48" x 72"	48" x 64"	48" x 60"
54" x 72"	54" x 64"	54" x 60"
60" x 72"	60" x 64"	60" x 60"
66" x 72"	66" x 64"	66" x 60"
72" x 72"	72" x 64"	72" x 60"

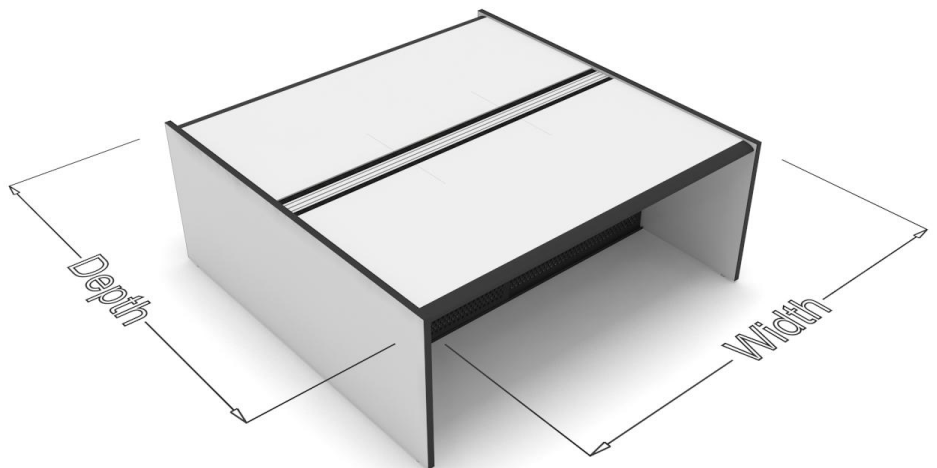
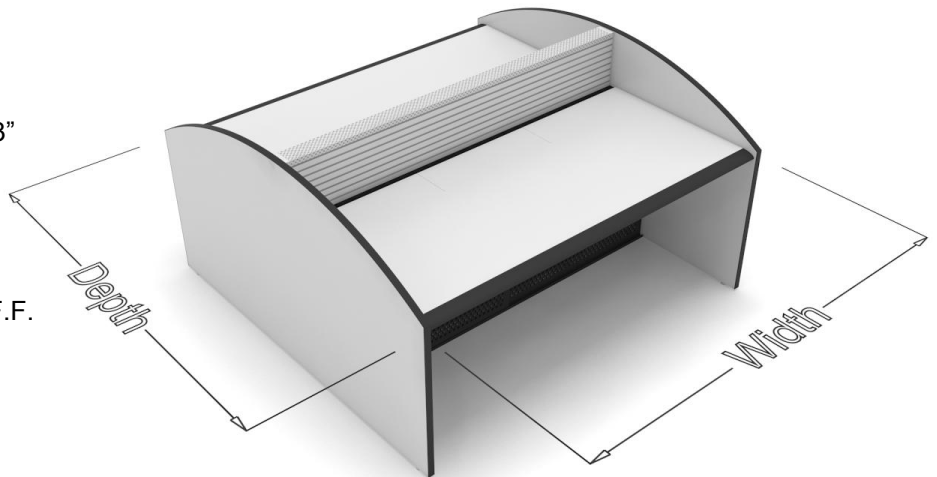

Step 2

Specify Type Of Trading Desk

Trading Desks can be specified with our industry-standard 10" slotwall or our 1" x 3" toolbar.

Custom heights of slotwall are available.

Our slotwall and toolbar can accept all industry standard monitor arms.

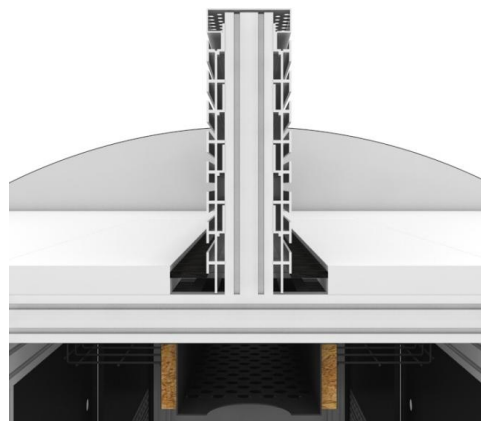

10" Slotwall

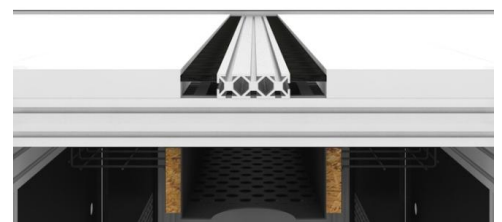

1" x 3" Toolbar

Step 3

Specify Cladding

End Panel Options

Custom shapes are also available.

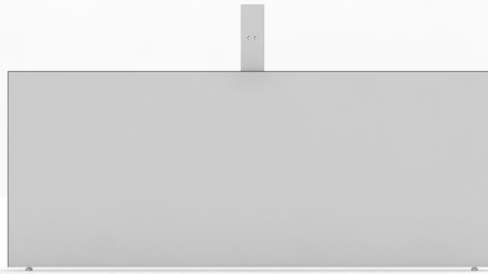

Low Rectangular
w/ Aluminum End Cap

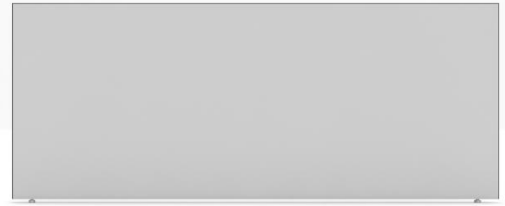

Low Rectangular

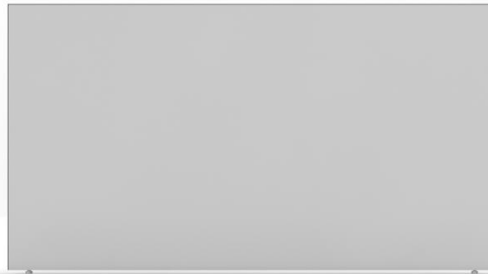

Rectangular

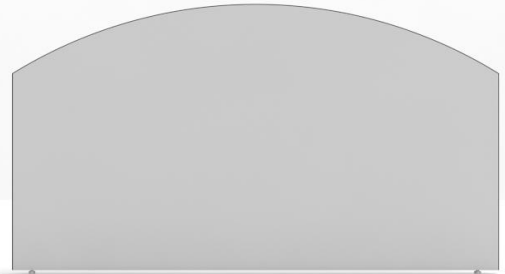

Radiused

Worksurface Options

Custom curves, angles & radii are also available.



Straight Worksurface
w/ In-Fills



Body-Well Worksurface
w/ In-Fills

Nosing Options

PVC or wood nosing options are available. Most can be fit to gentle curves and angles.



PVC - "Ovoid"

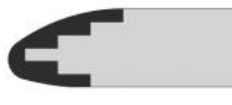

PVC - "Uni-Arc"



PVC - "T-Mold"



PVC - "3mm"

Custom wood nosing profiles are available as well.



Wood - "Ellipsoid"



Wood - "Bullnose"



Wood - "3mm"

Step 4

Specify Options & Accessories

Front Door Options

Sliding / liftout steel doors or hinged doors are standard. Custom door perforations, vents, and pulls are also available.

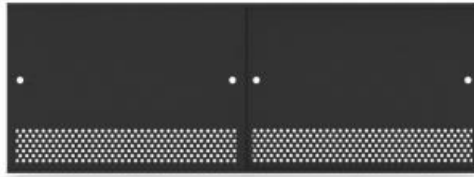

Sliding / Liftout
Steel Doors



Hinged Doors

CPU Shelf Options

Fixed and sliding CPU shelves shown here.

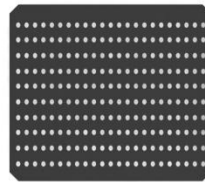

Fixed CPU Shelf



Sliding CPU Shelf

Pedestal Options

All pedestals can be fixed or mobile. File drawers are designed for letter / legal file sizes.

Custom pedestals and cabinets are available as well.



Box/Box/File



Box/Box/File w/
Space Saver
Return Top



Box/Box/File w/
Full Return Top



File/File



2 High
Lateral File



3 High
Lateral File



4 High
Lateral File



Box/Box/File
w/ Bookcase

Step 5

Additional Options

You can customize almost any of our standard components to create a truly unique desking solution for your needs.

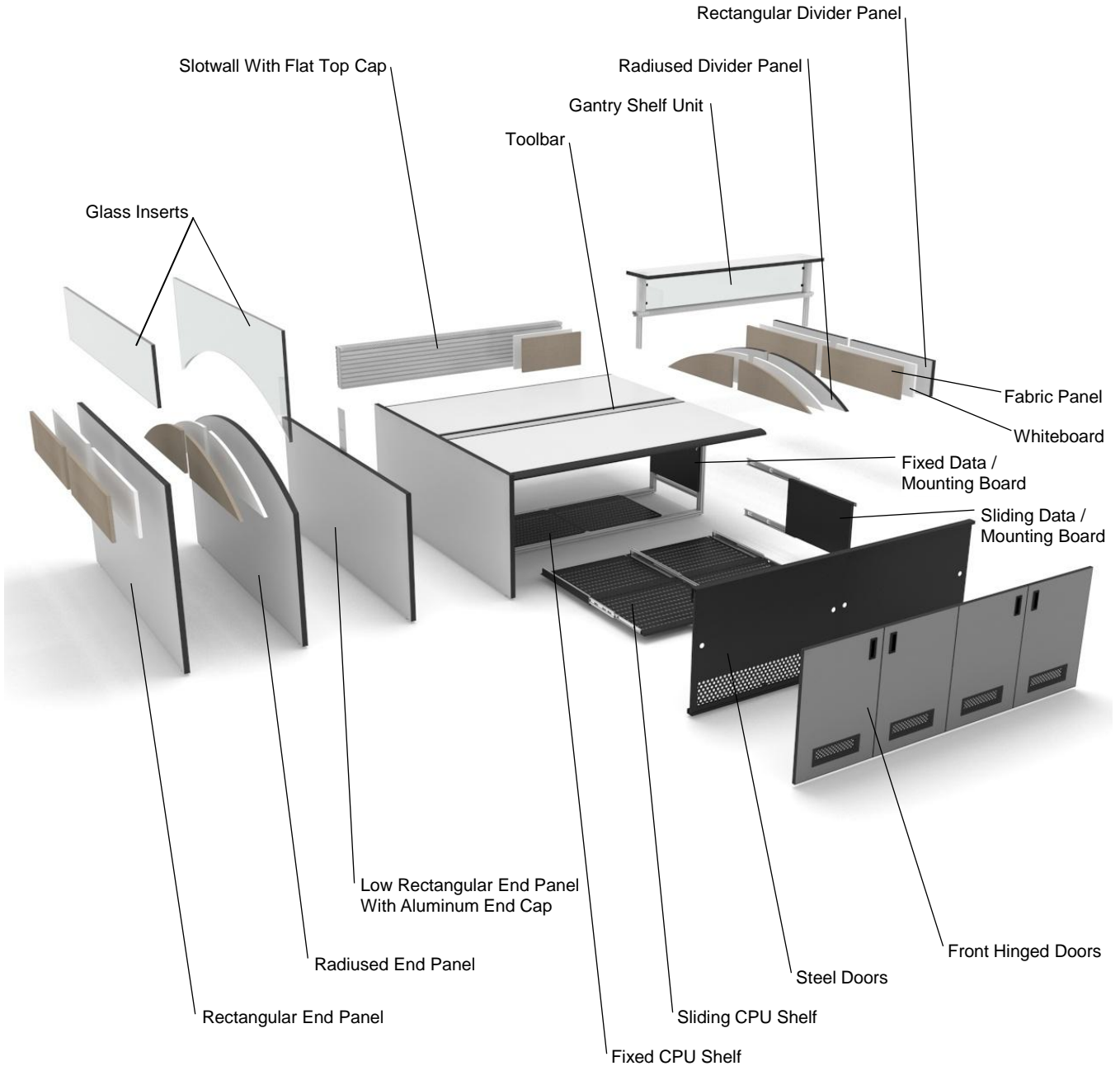

Step 6

Finishing Touches

Almost all vertical and horizontal surfaces can be specified with a laminate or veneer finish.

Wilsonart is our preferred vendor of laminates, with almost all standard and premium laminates available. We also use Formica, Nevamar, Laminart, and Pionite.

Laminate



Black



Slate Gray
D91-60



North Sea
D90-60



Dove Gray
D92-60



Featherstone
D72-60



Alabaster
D431-60



Graphite
Nebula
4623-60

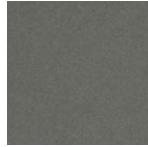

Twilight
Zephyr
4845-60



White
Nebula
4621-60

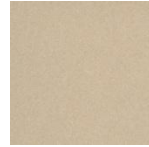

Desert
Zephyr
4841-60



Putty
1503-60



Wallaby
D439-60

Veneer

We offer many different woods and custom stains to get a pristine veneer finish. We can also match any architectural or custom finish.

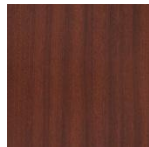

Walnut

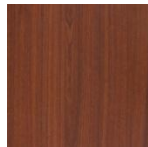

Mahogany

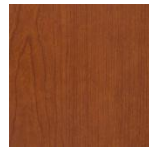

Cherry

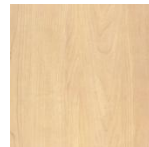

Maple

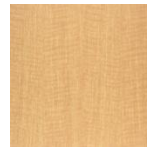

Anigre

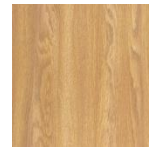

Oak

Steel

Steel standard finish is black textured powdercoat.

Aluminum standard finish is clear anodized.



Black
Powdercoat

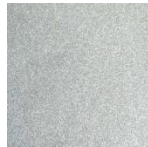

Lazy Silver
Powdercoat



Clear
Anodized



Black
Anodized

Aluminum

Fabric

We utilize fabric from most manufacturers.



Arcorm
Bark



Maharam
C340



Maharam
901580



Guilford
2539-031

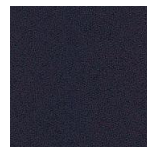

Guilford
2335-2085



Allsteel
Narrative
Falu Red